

# Držák vrtací tyče E2 – 25 x 20

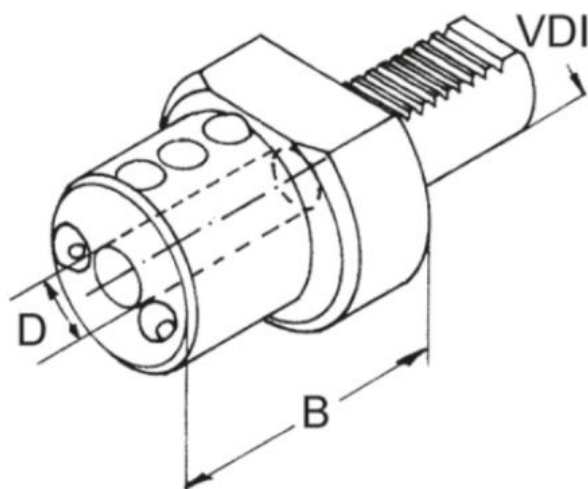
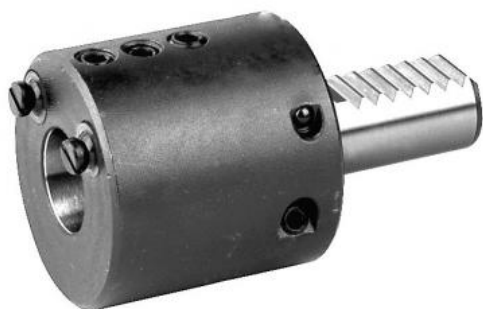

**Kód produktu:** 47-E2-25-20  
**EAN:** 4260073573832  
**Celní tarif:** 8466 1031  
**Hmotnost:** 0,80 kg  
**Dostupnost:** skladem

1 506,61 Kč bez DPH  
~~2 284,00 Kč~~ **1 823,00 Kč s DPH**  
61,98 € bez DPH  
~~94,00 €~~ **75,00 € s DPH**

VDI	D mm	B mm
16	6	44
16	8	44
16	10	44
16	12	44
16	16	44
20	8	50
20	10	50
20	12	50
20	16	50
20	20	50
20	25	60
25	8	50
25	10	50
25	12	50
25	16	50
25	20	50
25	25	60

## Parametry

**B** 50

**D** 20

**VDI** 25

Tento produkt najdete v našem [KATALOGU na straně 168 \(2021\)](#)